





FC A 4

Cable mounts for angles 40 mm

Material: Stainless steel AISI 304
Polyamide with black glass fiber,
resistant to UV radiation

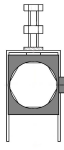
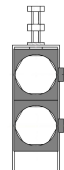
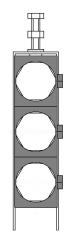
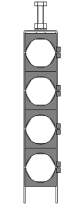

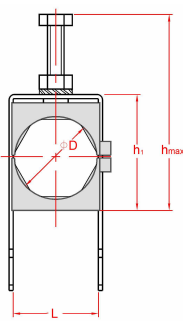
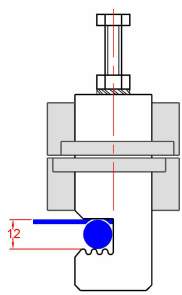

Typ	Kod	Typ kabelu	D	L	h1	h _{max}	 Nm		
	FCA4 1 x 5 mm	CNT 200	4,9 – 5,1	22	23	68	4	50	3,6
	FCA4 1 x 6,1mm	CNT 240	5,9 – 6,2	22	23	68	4	50	3,6
	FCA4 1 x (...)	Fiber optic	all diameter	22	23	68	4	50	3,6
	FCA4 1 x 8 mm	RFF 1/4" -50, SCF 14-50, FSJ1-50A	7 – 8	22	23	68	4	50	3,6
	FCA4 1 x 1/4" (9)	LDF 1-50	8 – 9,2	22	23	68	4	50	3,5
	FCA4 1 x 1/4" (10)	LCF 14-50, FSJ2-50, RG 8, RG 213, H 1000	9,8 – 10,5	22	23	68	4	50	3,5
	FCA4 1 x 1/4" (11)	RF 3/8"-50, LCF38-50, LDF2-50, RG 214	10,5 – 11,5	22	23	68	4	50	3,5
	FCA4 1 x 3/8" (14)	RFF 1/2"-50, SCF 12-50, FSJ4-50B	13 - 14	22	28	73	4	50	3,5
	FCA4 1 x 1/2" (17)	RF 1/2"-50, LCF 12-50, LDF4-50A	16 - 17	22	28	73	4	50	3,2
	FCA4 1 x (...)	Power cable		34	44	89	6	50	6,2
	FCA4 1 x 19,5	MCMK 2 x 16 + 16 Feederless DC cable	19,3-19,8	34	44	89	6	50	6,2
	FCA4 1 x 7/8" (28)	RF 7/8"-50, LCF78-50A, LDF5-50A	27 – 28	34	44	89	6	50	5,7
	FCA4 1 x 1.1/4" (40)	RF1 1/4"-50, LCFS 114-50A, LDF6-50	39 – 40	46	67	117	8	50	9,0
	FCA4 1 x 1.5/8" (52)	RF1 5/8"-50,LCF158-50A, LDF7-50A	50 – 52	58	68	113	8	50	11,0
	FCA4 1 x 2.1/4" (60)	RF 2 1/4"-50, LCF214-50A, LDF12-50	59 - 60	67	80	130	8	25	7,5
		FCA4 2 x 5 mm	CNT 200	4,9 – 5,1	22	43	88	4	50
FCA4 2 x 6,1mm		CNT 240	5,9 – 6,2	22	43	88	4	50	5
FCA4 2 x (...)		Fiber optic	all diameter	22	43	88	4	50	5
FCA4 2 x 8 mm		RFF 1/4" -50, SCF 14-50, FSJ1-50A	7 – 8	22	43	88	4	50	5
FCA4 2 x 1/4" (9)		LDF 1-50	8 – 9,2	22	43	88	4	50	5
FCA4 2 x 1/4" (10)		LCF 14-50, FSJ2-50, RG 8, RG 213, H 1000	9,8 – 10,5	22	43	88	4	50	5
FCA4 2 x 1/4" (11)		RF 3/8"-50, LCF38-50, LDF2-50, RG 214	10,5 – 11,5	22	43	88	4	50	5
FCA4 2 x 3/8" (14)		RFF 1/2"-50, SCF 12-50, FSJ4-50B	13 - 14	22	48	93	4	50	4,9
FCA4 2 x 1/2" (17)		RF 1/2"-50, LCF 12-50, LDF4-50A	16 - 17	22	48	93	4	50	4,7
FCA4 2 x (...)		Power cable		34	83	128	6	50	10
FCA4 2 x 19,5		MCMK 2 x 16 + 16 Feederless DC cable	19,3-19,8	34	83	128	6	50	10
FCA4 2 x 7/8" (28)		RF 7/8"-50, LCF78-50A, LDF5-50A	27 – 28	34	83	128	6	50	10
FCA4 2 x 1.1/4" (40)		RF1 1/4"-50, LCFS 114-50A, LDF6-50	39 – 40	46	118	168	8	25	7,2
FCA4 2 x 1.5/8" (52)		RF1 5/8"-50,LCF158-50A, LDF7-50A	50 – 52	58	130	180	8	25	9
FCA4 2 x 2.1/4" (60)		RF 2 1/4"-50, LCF214-50A, LDF12-50	59 - 60	67	153	203	8	20	9,2
		FCA4 3 x 5 mm	CNT 200	4,9 – 5,1	22	63	108	4	50
	FCA4 3 x 6,1mm	CNT 240	5,9 – 6,2	22	63	108	4	50	6,5
	FCA4 3 x (...)	Fiber optic	all diameter	22	63	108	4	50	6,5
	FCA4 3 x 8 mm	RFF 1/4" -50, SCF 14-50, FSJ1-50A	7 – 8	22	63	108	4	50	6,5
	FCA4 3 x 1/4" (9)	LDF 1-50	8 – 9,2	22	63	108	4	50	6,5
	FCA4 3 x 1/4" (10)	LCF 14-50, FSJ2-50, RG 8, RG 213, H 1000	9,8 – 10,5	22	63	108	4	50	6,5
	FCA4 3 x 1/4" (11)	RF 3/8"-50, LCF38-50, LDF2-50, RG 214	10,5 – 11,5	22	63	108	4	50	6,5
	FCA4 3 x 3/8" (14)	RFF 1/2"-50, SCF 12-50, FSJ4-50B	13 - 14	22	68	113	4	50	6
	FCA4 3 x 1/2" (17)	RF 1/2"-50, LCF 12-50, LDF4-50A	16 - 17	22	68	113	4	50	6
	FCA4 3 x (...)	Power cable		34	122	167	6	50	13,3
	FCA4 3 x 19,5	MCMK 2 x 16 + 16 Feederless DC cable	19,3-19,8	34	122	167	6	50	13,3
	FCA4 3 x 7/8" (28)	RF 7/8"-50, LCF78-50A, LDF5-50A	27 – 28	34	122	167	6	50	13,3
	FCA4 3 x 1.1/4" (40)	RF1 1/4"-50, LCFS 114-50A, LDF6-50	39 – 40	46	168	218	8	25	9,2
	FCA4 3 x 1.5/8" (52)	RF1 5/8"-50,LCF158-50A, LDF7-50A	50 – 52	58	193	243	8	25	11,7
	FCA4 3 x 2.1/4" (60)	RF 2 1/4"-50, LCF214-50A, LDF12-50	59 - 60	67	227	277	8	20	12
		FCA4 4 x 5 mm	CNT 200	4,9 – 5,1	22	82	127	4	50
FCA4 4 x 6,1mm		CNT 240	5,9 – 6,2	22	82	127	4	50	8
FCA4 4 x (...)		Fiber optic	all diameter	22	82	127	4	50	8
FCA4 4 x 8 mm		RFF 1/4" -50, SCF 14-50, FSJ1-50A	7 – 8	22	82	127	4	50	7,7
FCA4 4 x 1/4" (9)		LDF 1-50	8 – 9,2	22	82	127	4	50	7,7
FCA4 4 x 1/4" (10)		LCF 14-50, FSJ2-50, RG 8, RG 213, H 1000	9,8 – 10,5	22	82	127	4	50	7,7
FCA4 4 x 1/4" (11)		RF 3/8"-50, LCF38-50, LDF2-50, RG 214	10,5 – 11,5	22	82	127	4	50	7,7
FCA4 4 x 3/8" (14)		RFF 1/2"-50, SCF 12-50, FSJ4-50B	13 - 14	22	88	133	4	50	8
FCA4 4 x 1/2" (17)		RF 1/2"-50, LCF 12-50, LDF4-50A	16 - 17	22	88	133	4	50	8
FCA4 4 x (...)		Power cable		34	161	206	6	25	9,6
FCA4 4 x 19,5		MCMK 2 x 16 + 16 Feederless DC cable	19,3-19,8	34	161	206	6	25	9,6
FCA4 4 x 7/8" (28)		RF 7/8"-50, LCF78-50A, LDF5-50A	27 – 28	34	161	206	6	25	9,6
FCA4 4 x 1.1/4" (40)		RF1 1/4"-50, LCFS 114-50A, LDF6-50	39 – 40	46	218	268	8	25	11
FCA4 4 x 1.5/8" (52)		RF1 5/8"-50,LCF158-50A, LDF7-50A	50 – 52	58	256	306	8	25	12,5
FCA4 4 x 2.1/4" (60)		RF 2 1/4"-50, LCF214-50A, LDF12-50	59 - 60	67	227	349	8	15	8
		FCA4 4 x (...) 2R	Fiber optic		34	44	89	4	50
	FCA4 4 x 1/4" (10) 2R	LCF 14-50, FSJ2-50, RG 8, RG 213, H 1000	9,8 – 10,5	34	44	89	4	50	7
	FCA4 4 x 1/4" (11) 2R	RF 3/8"-50, LCF38-50, LDF2-50, RG 214	10,5 – 11,5	34	44	89	4	50	7



FC B

Cable mount for section 3 - 12mm

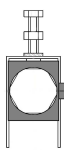
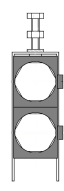
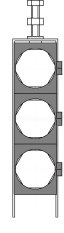
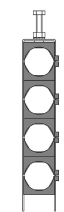
Material: Stainless steel AISI 304
Polyamide with black glass fiber,
resistant to UV radiation



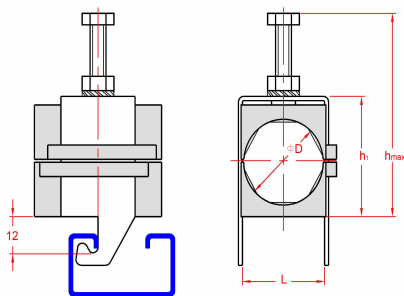





Typ	Kod	Typ kabelu	D	L	h1	h _{max}	 Nm		 kg
	FCB 1 x 5 mm	CNT 200	4,9 – 5,1	22	23	53	4	50	3,6
	FCB 1 x 6,1mm	CNT 240	5,9 – 6,2	22	23	53	4	50	3,6
	FCB 1 x (...)	Fiber optic	all diameter	22	23	53	4	50	3,6
	FCB 1 x 8 mm	RFF 1/4" -50, SCF 14-50, FSJ1-50A	7 – 8	22	23	53	4	50	3,6
	FCB 1 x 1/4" (9)	LDF 1-50	8 – 9,2	22	23	53	4	50	3,5
	FCB 1 x 1/4" (10)	LCF 14-50, FSJ2-50, RG 8, RG 213, H 1000	9,8 – 10,5	22	23	53	4	50	3,5
	FCB 1 x 1/4" (11)	RF 3/8"-50, LCF38-50, LDF2-50, RG 214	10,5 – 11,5	22	23	53	4	50	3,5
	FCB 1 x 3/8" (14)	RFF 1/2"-50, SCF 12-50, FSJ4-50B	13 – 14	22	28	58	4	50	3,5
	FCB 1 x 1/2" (17)	RF 1/2"-50, LCF 12-50, LDF4-50A	16 – 17	22	28	58	4	50	3,5
	FCB 1 x (...)	Power cable		34	28	58	4	50	3,2
	FCB 1 x 19,5	MCMK 2 x 16 + 16 Feederless DC cable	19,3-19,8	34	44	74	6	50	6,2
	FCB 1 x 7/8" (28)	RF 7/8"-50, LCF78-50A, LDF5-50A	27 – 28	34	44	74	6	50	5,7
	FCB 1 x 1.1/4" (40)	RF1 1/4"-50, LCFS 114-50A, LDF6-50	39 – 40	46	67	107	8	50	9,0
	FCB 1 x 1.5/8" (52)	RF1 5/8"-50,LCF158-50A, LDF7-50A	50 – 52	58	68	108	8	50	11,0
FCB 1 x 2.1/4" (60)	RF 2 1/4"-50, LCF214-50A, LDF12-50	59 – 60	67	80	120	8	25	7,5	
	FCB 2 x 5 mm	CNT 200	4,9 – 5,1	22	43	73	4	50	5
	FCB 2 x 6,1mm	CNT 240	5,9 – 6,2	22	43	73	4	50	5
	FCB 2 x (...)	Fiber optic	all diameter	22	43	73	4	50	5
	FCB 2 x 8 mm	RFF 1/4" -50, SCF 14-50, FSJ1-50A	7 – 8	22	43	73	4	50	5
	FCB 2 x 1/4" (9)	LDF 1-50	8 – 9,2	22	43	73	4	50	5
	FCB 2 x 1/4" (10)	LCF 14-50, FSJ2-50, RG 8, RG 213, H 1000	9,8 – 10,5	22	43	73	4	50	5
	FCB 2 x 1/4" (11)	RF 3/8"-50, LCF38-50, LDF2-50, RG 214	10,5 – 11,5	22	43	73	4	50	5
	FCB 2 x 3/8" (14)	RFF 1/2"-50, SCF 12-50, FSJ4-50B	13 – 14	22	48	78	4	50	4,9
	FCB 2 x 1/2" (17)	RF 1/2"-50, LCF 12-50, LDF4-50A	16 – 17	22	48	78	4	50	4,9
	FCB 2 x (...)	Powe cable		34	48	78	4	50	4,7
	FCB 2 x 19,5	MCMK 2 x 16 + 16 Feederless DC cable	19,3-19,8	34	83	113	6	50	9
	FCB 2 x 7/8" (28)	RF 7/8"-50, LCF78-50A, LDF5-50A	27 – 28	34	83	113	6	50	10
	FCB 2 x 1.1/4" (40)	RF1 1/4"-50, LCFS 114-50A, LDF6-50	39 – 40	46	118	158	8	25	7,2
	FCB 2 x 1.5/8" (52)	RF1 5/8"-50,LCF158-50A, LDF7-50A	50 – 52	58	130	170	8	25	9
FCB 2 x 2.1/4" (60)	RF 2 1/4"-50, LCF214-50A, LDF12-50	59 – 60	67	153	193	8	20	9,2	
	FCB 3 x 5 mm	CNT 200	4,9 – 5,1	22	63	93	4	50	6,5
	FCB 3 x 6,1mm	CNT 240	5,9 – 6,2	22	63	93	4	50	6,5
	FCB 3 x (...)	Fiber optic	all diameter	22	63	93	4	50	6,5
	FCB 3 x 8 mm	RFF 1/4" -50, SCF 14-50, FSJ1-50A	7 – 8	22	63	93	4	50	6,5
	FCB 3 x 1/4" (9)	LDF 1-50	8 – 9,2	22	63	93	4	50	6,5
	FCB 3 x 1/4" (10)	LCF 14-50, FSJ2-50, RG 8, RG 213, H 1000	9,8 – 10,5	22	63	93	4	50	6,5
	FCB 3 x 1/4" (11)	RF 3/8"-50, LCF38-50, LDF2-50, RG 214	10,5 – 11,5	22	63	93	4	50	6,5
	FCB 3 x 3/8" (14)	RFF 1/2"-50, SCF 12-50, FSJ4-50B	13 – 14	22	68	98	4	50	6
	FCB 3 x 1/2" (17)	RF 1/2"-50, LCF 12-50, LDF4-50A	16 – 17	22	68	98	4	50	6
	FCB 3 x (...)	Power cable		34	68	98	4	50	6
	FCB 3 x 19,5	MCMK 2 x 16 + 16 Feederless DC cable	19,3-19,8	34	122	152	6	50	13
	FCB 3 x 7/8" (28)	RF 7/8"-50, LCF78-50A, LDF5-50A	27 – 28	34	122	152	6	50	13,3
	FCB 3 x 1.1/4" (40)	RF1 1/4"-50, LCFS 114-50A, LDF6-50	39 – 40	46	168	208	8	25	9,2
	FCB 3 x 1.5/8" (52)	RF1 5/8"-50,LCF158-50A, LDF7-50A	50 – 52	58	193	233	8	25	11,7
FCB 3 x 2.1/4" (60)	RF 2 1/4"-50, LCF214-50A, LDF12-50	59 – 60	67	227	237	8	20	12	
	FCB 4 x 5 mm	CNT 200	4,9 – 5,1	22	82	112	4	50	8
	FCB 4 x 6,1mm	CNT 240	5,9 – 6,2	22	82	112	4	50	8
	FCB 4 x (...)	Fiber optic	all diameter	22	82	112	4	50	8
	FCB 4 x 8 mm	RFF 1/4" -50, SCF 14-50, FSJ1-50A	7 – 8	22	82	112	4	50	7,7
	FCB 4 x 1/4" (9)	LDF 1-50	8 – 9,2	22	82	112	4	50	7,7
	FCB 4 x 1/4" (10)	LCF 14-50, FSJ2-50, RG 8, RG 213, H 1000	9,8 – 10,5	22	82	112	4	50	7,7
	FCB 4 x 1/4" (11)	RF 3/8"-50, LCF38-50, LDF2-50, RG 214	10,5 – 11,5	22	82	112	4	50	7,7
	FCB 4 x 3/8" (14)	RFF 1/2"-50, SCF 12-50, FSJ4-50B	13 – 14	22	88	118	4	50	8
	FCB 4 x 1/2" (17)	RF 1/2"-50, LCF 12-50, LDF4-50A	16 – 17	22	88	118	4	50	8
	FCB 4 x (...)	Power cable		34	88	118	4	50	8
	FCB 4 x 19,5	MCMK 2 x 16 + 16 Feederless DC cable	19,3-19,8	34	161	191	6	50	9,7
	FCB 4 x 7/8" (28)	RF 7/8"-50, LCF78-50A, LDF5-50A	27 – 28	34	161	191	6	50	9,6
	FCB 4 x 1.1/4" (40)	RF1 1/4"-50, LCFS 114-50A, LDF6-50	39 – 40	46	218	258	8	25	11
	FCB 4 x 1.5/8" (52)	RF1 5/8"-50,LCF158-50A, LDF7-50A	50 – 52	58	256	296	8	25	12,5
FCB 4 x 2.1/4" (60)	RF 2 1/4"-50, LCF214-50A, LDF12-50	59 – 60	67	227	329	8	15	8	
	FCB 4 x ... 2R	Fiber optic	all diameter	34	44	74	4	50	7
	FCB 4 x 1/4" (10) 2R	LCF 14-50, FSJ2-50, RG 8, RG 213, H 1000	9,8 – 10,5	34	44	74	4	50	7
	FCB 4 x 1/4" (11) 2R	RF 3/8"-50, LCF38-50, LDF2-50, RG 214	10,5 – 11,5	34	44	74	4	50	7



FCC C

Cable mounts for sections 40 x 22 mm, flat bars

Material: Stainless steel AISI 304
Polyamide with black glass fiber,
resistant to UV radiation



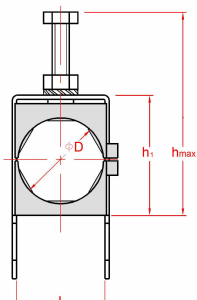
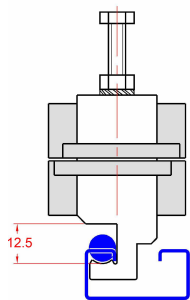



Typ	Kod	Typ kabelu	D	L	h1	h _{max}	 Nm		
	FCC 1 x 5 mm	CNT 200	4,9 – 5,1	22	23	53	4	50	3,6
	FCC 1 x 6,1mm	CNT 240	5,9 – 6,2	22	23	53	4	50	3,6
	FCC 1 x (...)	Fiber optic	all diameter	22	23	53	4	50	3,6
	FCC 1 x 8 mm	RFF 1/4" -50, SCF 14-50, FSJ1-50A	7 – 8	22	23	53	4	50	3,6
	FCC 1 x 1/4" (9)	LDF 1-50	8 – 9,2	22	23	53	4	50	3,5
	FCC 1 x 1/4" (10)	LCF 14-50, FSJ2-50, RG 8, RG 213, H 1000	9,8 – 10,5	22	23	53	4	50	3,5
	FCC 1 x 1/4" (11)	RF 3/8"-50, LCF38-50, LDF2-50, RG 214	10,5 – 11,5	22	23	53	4	50	3,5
	FCC 1 x 3/8" (14)	RFF 1/2"-50, SCF 12-50, FSJ4-50B	13 - 14	22	28	58	4	50	3,5
	FCC 1 x 1/2" (17)	RF 1/2"-50, LCF 12-50, LDF4-50A	16 - 17	22	28	58	4	50	3,5
	FCC 1 x (...)	Power cable		34	28	58	4	50	3,2
	FCC 1 x 19,5	MCMK 2 x 16 + 16 Feederless DC cable	19,3-19,8	34	44	74	6	50	6,2
	FCC 1 x 7/8" (28)	RF 7/8"-50, LCF78-50A, LDF5-50A	27 – 28	34	44	74	6	50	5,7
	FCC 1 x 1.1/4" (40)	RF1 1/4"-50, LCFS 114-50A, LDF6-50	39 – 40	46	67	107	8	50	9,0
	FCC 1 x 1.5/8" (52)	RF1 5/8"-50,LCF158-50A, LDF7-50A	50 – 52	58	68	108	8	50	11,0
FCC 1 x 2.1/4" (60)	RF 2 1/4"-50, LCF214-50A, LDF12-50	59 - 60	67	80	120	8	25	7,5	
	FCC 2 x 5 mm	CNT 200	4,9 – 5,1	22	43	73	4	50	5
	FCC 2 x 6,1mm	CNT 240	5,9 – 6,2	22	43	73	4	50	5
	FCC 2 x (...)	Fiber optic	all diameter	22	43	73	4	50	5
	FCC 2 x 8 mm	RFF 1/4" -50, SCF 14-50, FSJ1-50A	7 – 8	22	43	73	4	50	5
	FCC 2 x 1/4" (9)	LDF 1-50	8 – 9,2	22	43	73	4	50	5
	FCC 2 x 1/4" (10)	LCF 14-50, FSJ2-50, RG 8, RG 213, H 1000	9,8 – 10,5	22	43	73	4	50	5
	FCC 2 x 1/4" (11)	RF 3/8"-50, LCF38-50, LDF2-50, RG 214	10,5 – 11,5	22	43	73	4	50	5
	FCC 2 x 3/8" (14)	RFF 1/2"-50, SCF 12-50, FSJ4-50B	13 - 14	22	48	78	4	50	4,9
	FCC 2 x 1/2" (17)	RF 1/2"-50, LCF 12-50, LDF4-50A	16 - 17	22	48	78	4	50	4,9
	FCC 2 x (...)	Power cable		34	48	78	4	50	4,7
	FCC 2 x 19,5	MCMK 2 x 16 + 16 Feederless DC cable	19,3-19,8	34	83	113	6	50	9
	FCC 2 x 7/8" (28)	RF 7/8"-50, LCF78-50A, LDF5-50A	27 – 28	34	83	113	6	50	10
	FCC 2 x 1.1/4" (40)	RF1 1/4"-50, LCFS 114-50A, LDF6-50	39 – 40	46	118	158	8	25	7,2
	FCC 2 x 1.5/8" (52)	RF1 5/8"-50,LCF158-50A, LDF7-50A	50 – 52	58	130	170	8	25	9
FCC 2 x 2.1/4" (60)	RF 2 1/4"-50, LCF214-50A, LDF12-50	59 - 60	67	153	193	8	20	9,2	
	FCC 3 x 5 mm	CNT 200	4,9 – 5,1	22	63	93	4	50	6,5
	FCC 3 x 6,1mm	CNT 240	5,9 – 6,2	22	63	93	4	50	6,5
	FCC 3 x (...)	Fiber optic	all diameter	22	63	93	4	50	6,5
	FCC 3 x 8 mm	RFF 1/4" -50, SCF 14-50, FSJ1-50A	7 – 8	22	63	93	4	50	6,5
	FCC 3 x 1/4" (9)	LDF 1-50	8 – 9,2	22	63	93	4	50	6,5
	FCC 3 x 1/4" (10)	LCF 14-50, FSJ2-50, RG 8, RG 213, H 1000	9,8 – 10,5	22	63	93	4	50	6,5
	FCC 3 x 1/4" (11)	RF 3/8"-50, LCF38-50, LDF2-50, RG 214	10,5 – 11,5	22	63	93	4	50	6,5
	FCC 3 x 3/8" (14)	RFF 1/2"-50, SCF 12-50, FSJ4-50B	13 - 14	22	68	98	4	50	6
	FCC 3 x 1/2" (17)	RF 1/2"-50, LCF 12-50, LDF4-50A	16 - 17	22	68	98	4	50	6
	FCC 3 x (...)	Power cable		34	68	98	4	50	6
	FCC 3 x 19,5	MCMK 2 x 16 + 16 Feederless DC cable	19,3-19,8	34	122	152	6	50	13
	FCC 3 x 7/8" (28)	RF 7/8"-50, LCF78-50A, LDF5-50A	27 – 28	34	122	152	6	50	13,3
	FCC 3 x 1.1/4" (40)	RF1 1/4"-50, LCFS 114-50A, LDF6-50	39 – 40	46	168	208	8	25	9,2
	FCC 3 x 1.5/8" (52)	RF1 5/8"-50,LCF158-50A, LDF7-50A	50 – 52	58	193	233	8	25	11,7
FCC 3 x 2.1/4" (60)	RF 2 1/4"-50, LCF214-50A, LDF12-50	59 - 60	67	227	237	8	20	12	
	FCC 4 x 5 mm	CNT 200	4,9 – 5,1	22	82	112	4	50	8
	FCC 4 x 6,1mm	CNT 240	5,9 – 6,2	22	82	112	4	50	8
	FCC 4 x (...)	Fiber optic	all diameter	22	82	112	4	50	8
	FCC 4 x 8 mm	RFF 1/4" -50, SCF 14-50, FSJ1-50A	7 – 8	22	82	112	4	50	7,7
	FCC 4 x 1/4" (9)	LDF 1-50	8 – 9,2	22	82	112	4	50	7,7
	FCC 4 x 1/4" (10)	LCF 14-50, FSJ2-50, RG 8, RG 213, H 1000	9,8 – 10,5	22	82	112	4	50	7,7
	FCC 4 x 1/4" (11)	RF 3/8"-50, LCF38-50, LDF2-50, RG 214	10,5 – 11,5	22	82	112	4	50	7,7
	FCC 4 x 3/8" (14)	RFF 1/2"-50, SCF 12-50, FSJ4-50B	13 - 14	22	88	118	4	50	8
	FCC 4 x 1/2" (17)	RF 1/2"-50, LCF 12-50, LDF4-50A	16 - 17	22	88	118	4	50	8
	FCC 4 x (...)	Power cable		34	88	118	4	50	8
	FCC 4 x 19,5	MCMK 2 x 16 + 16 Feederless DC cable	19,3-19,8	34	161	191	6	50	9,7
	FCC 4 x 7/8" (28)	RF 7/8"-50, LCF78-50A, LDF5-50A	27 – 28	34	161	191	6	50	9,6
	FCC 4 x 1.1/4" (40)	RF1 1/4"-50, LCFS 114-50A, LDF6-50	39 – 40	46	218	258	8	25	11
	FCC 4 x 1.5/8" (52)	RF1 5/8"-50,LCF158-50A, LDF7-50A	50 – 52	58	256	296	8	25	12,5
FCC 4 x 2.1/4" (60)	RF 2 1/4"-50, LCF214-50A, LDF12-50	59 - 60	67	227	329	8	15	8	
	FCC 4 x (...) 2R	Fiber optic		34	44	74	4	50	7
	FCC 4 x 1/4" (10) 2R	LCF 14-50, FSJ2-50, RG 8, RG 213, H 1000	9,8 – 10,5	34	44	74	4	50	7
	FCC 4 x 1/4" (11) 2R	RF 3/8"-50, LCF38-50, LDF2-50, RG 214	10,5 – 11,5	34	44	74	4	50	7

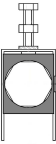

FC E

Cable mounts for sections

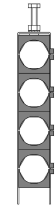
Material: Stainless steel AISI 304
Polyamide with black glass fiber,
resistant to UV radiation

Typ	Kod	Typ kabelu	D	L	h1	h _{max}	 Nm			
	FCE 1 x 5 mm	CNT 200	4,9 – 5,1	22	23	53	4	50	3,6	
	FCE 1 x 6,1mm	CNT 240	5,9 – 6,2	22	23	53	4	50	3,6	
	FCE 1 x (...)	Fiber optic	all diameter	22	23	53	4	50	3,6	
	FCE 1 x 8 mm	RFF 1/4" -50, SCF 14-50, FSJ1-50A	7 – 8	22	23	53	4	50	3,6	
	FCE 1 x 1/4" (9)	LDF 1-50	8 – 9,2	22	23	53	4	50	3,5	
	FCE 1 x 1/4" (10)	LCF 14-50, FSJ2-50, RG 8, RG 213, H 1000	9,8 – 10,5	22	23	53	4	50	3,5	
	FCE 1 x 1/4" (11)	RF 3/8"-50, LCF38-50, LDF2-50, RG 214	10,5 – 11,5	22	23	53	4	50	3,5	
	FCE 1 x 3/8" (14)	RFF 1/2"-50, SCF 12-50, FSJ4-50B	13 - 14	22	28	58	4	50	3,5	
	FCE 1 x 1/2" (17)	RF 1/2"-50, LCF 12-50, LDF4-50A	16 - 17	22	28	58	4	50	3,5	
	FCE 1 x (...)	Power cable			34	28	58	4	50	3,2
	FCE 1 x 19,5	MCMK 2 x 16 + 16 Feederless DC cable	19,3-19,8	34	44	74	6	50	6,2	
	FCE 1 x 7/8" (28)	RF 7/8"-50, LCF78-50A, LDF5-50A	27 – 28	34	44	74	6	50	5,7	
	FCE 1 x 1.1/4" (40)	RF1 1/4"-50, LCFs 114-50A, LDF6-50	39 – 40	46	67	107	8	50	9,0	
	FCE 1 x 1.5/8" (52)	RF1 5/8"-50, LCF158-50A, LDF7-50A	50 – 52	58	68	108	8	50	11,0	
FCE 1 x 2.1/4" (60)	RF 2 1/4"-50, LCF214-50A, LDF12-50	59 - 60	67	80	120	8	25	7,5		
	FCE 2 x 5 mm	CNT 200	4,9 – 5,1	22	43	73	4	50	5	
	FCE 2 x 6,1mm	CNT 240	5,9 – 6,2	22	43	73	4	50	5	
	FCE 2 x (...)	Fiber optic	all diameter	22	43	73	4	50	5	
	FCE 2 x 8 mm	RFF 1/4" -50, SCF 14-50, FSJ1-50A	7 – 8	22	43	73	4	50	5	
	FCE 2 x 1/4" (9)	LDF 1-50	8 – 9,2	22	43	73	4	50	5	
	FCE 2 x 1/4" (10)	LCF 14-50, FSJ2-50, RG 8, RG 213, H 1000	9,8 – 10,5	22	43	73	4	50	5	
	FCE 2 x 1/4" (11)	RF 3/8"-50, LCF38-50, LDF2-50, RG 214	10,5 – 11,5	22	43	73	4	50	5	
	FCE 2 x 3/8" (14)	RFF 1/2"-50, SCF 12-50, FSJ4-50B	13 - 14	22	48	78	4	50	4,9	
	FCE 2 x 1/2" (17)	RF 1/2"-50, LCF 12-50, LDF4-50A	16 - 17	22	48	78	4	50	4,9	
	FCE 2 x (...)	Power Cable			34	48	78	4	50	4,7
	FCE 2 x 19,5	MCMK 2 x 16 + 16 Feederless DC cable	19,3-19,8	34	83	113	6	50	9	
	FCE 2 x 7/8" (28)	RF 7/8"-50, LCF78-50A, LDF5-50A	27 – 28	34	83	113	6	50	10	
	FCE 2 x 1.1/4" (40)	RF1 1/4"-50, LCFs 114-50A, LDF6-50	39 – 40	46	118	158	8	25	7,2	
	FCE 2 x 1.5/8" (52)	RF1 5/8"-50, LCF158-50A, LDF7-50A	50 – 52	58	130	170	8	25	9	
FCE 2 x 2.1/4" (60)	RF 2 1/4"-50, LCF214-50A, LDF12-50	59 - 60	67	153	193	8	20	9,2		
	FCE 3 x 5 mm	CNT 200	4,9 – 5,1	22	63	93	4	50	6,5	
	FCE 3 x 6,1mm	CNT 240	5,9 – 6,2	22	63	93	4	50	6,5	
	FCE 3 x (...)	Fiber optic	all diameter	22	63	93	4	50	6,5	
	FCE 3 x 8 mm	RFF 1/4" -50, SCF 14-50, FSJ1-50A	7 – 8	22	63	93	4	50	6,5	
	FCE 3 x 1/4" (9)	LDF 1-50	8 – 9,2	22	63	93	4	50	6,5	
	FCE 3 x 1/4" (10)	LCF 14-50, FSJ2-50, RG 8, RG 213, H 1000	9,8 – 10,5	22	63	93	4	50	6,5	
	FCE 3 x 1/4" (11)	RF 3/8"-50, LCF38-50, LDF2-50, RG 214	10,5 – 11,5	22	63	93	4	50	6,5	
	FCE 3 x 3/8" (14)	RFF 1/2"-50, SCF 12-50, FSJ4-50B	13 - 14	22	68	98	4	50	6	
	FCE 3 x 1/2" (17)	RF 1/2"-50, LCF 12-50, LDF4-50A	16 - 17	22	68	98	4	50	6	
	FCE 3 x (...)	Power cable			34	68	98	4	50	6
	FCE 3 x 19,5	MCMK 2 x 16 + 16 Feederless DC cable	19,3-19,8	34	122	152	6	50	13	
	FCE 3 x 7/8" (28)	RF 7/8"-50, LCF78-50A, LDF5-50A	27 – 28	34	122	152	6	50	13,3	
	FCE 3 x 1.1/4" (40)	RF1 1/4"-50, LCFs 114-50A, LDF6-50	39 – 40	46	168	208	8	25	9,2	
	FCE 3 x 1.5/8" (52)	RF1 5/8"-50, LCF158-50A, LDF7-50A	50 – 52	58	193	233	8	25	11,7	
FCE 3 x 2.1/4" (60)	RF 2 1/4"-50, LCF214-50A, LDF12-50	59 - 60	67	227	237	8	20	12		
	FCE 4 x 5 mm	CNT 200	4,9 – 5,1	22	82	112	4	50	8	
	FCE 4 x 6,1mm	CNT 240	5,9 – 6,2	22	82	112	4	50	8	
	FCE 4 x (...)	Fiber optic	all diameter	22	82	112	4	50	8	
	FCE 4 x 8 mm	RFF 1/4" -50, SCF 14-50, FSJ1-50A	7 – 8	22	82	112	4	50	7,7	
	FCE 4 x 1/4" (9)	LDF 1-50	8 – 9,2	22	82	112	4	50	7,7	
	FCE 4 x 1/4" (10)	LCF 14-50, FSJ2-50, RG 8, RG 213, H 1000	9,8 – 10,5	22	82	112	4	50	7,7	
	FCE 4 x 1/4" (11)	RF 3/8"-50, LCF38-50, LDF2-50, RG 214	10,5 – 11,5	22	82	112	4	50	7,7	
	FCE 4 x 3/8" (14)	RFF 1/2"-50, SCF 12-50, FSJ4-50B	13 - 14	22	88	118	4	50	8	
	FCE 4 x 1/2" (17)	RF 1/2"-50, LCF 12-50, LDF4-50A	16 - 17	22	88	118	4	50	8	
	FCE 4 x (...)	Power cable			34	88	118	4	50	8
	FCE 4 x 19,5	MCMK 2 x 16 + 16 Feederless DC cable	19,3-19,8	34	161	191	6	50	9,7	
	FCE 4 x 7/8" (28)	RF 7/8"-50, LCF78-50A, LDF5-50A	27 – 28	34	161	191	6	50	9,6	
	FCE 4 x 1.1/4" (40)	RF1 1/4"-50, LCFs 114-50A, LDF6-50	39 – 40	46	218	258	8	25	11	
	FCE 4 x 1.5/8" (52)	RF1 5/8"-50, LCF158-50A, LDF7-50A	50 – 52	58	256	296	8	25	12,5	
FCE 4 x 2.1/4" (60)	RF 2 1/4"-50, LCF214-50A, LDF12-50	59 - 60	67	227	329	8	15	8		
	FCE 4 x (...)	Fiber optic	all diameter	34	44	74	4	50	7	
	FCE 4 x 1/4" (10) 2R	LCF 14-50, FSJ2-50, RG 8, RG 213, H 1000	9,8 – 10,5	34	44	74	4	50	7	
	FCE 4 x 1/4" (11) 2R	RF 3/8"-50, LCF38-50, LDF2-50, RG 214	10,5 – 11,5	34	44	74	4	50	7	

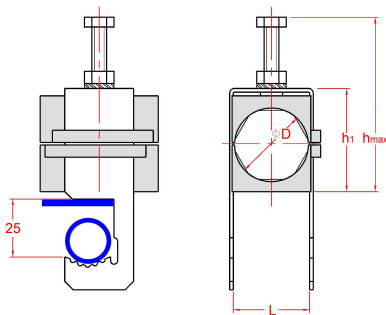

FC M

Cable mounts for flat bars, pipes 2-25 mm

Material: Stainless steel AISI 304
Polyamide with black glass fiber,
resistant to UV radiation

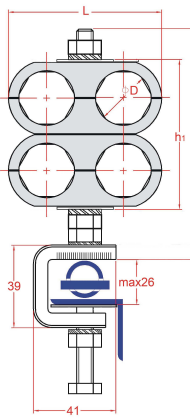

Typ	Kod	Typ kabelu	D	L	h1	h _{max}			
							Nm		
	FCM 1 x 5 mm	CNT 200	4,9 – 5,1	22	23	68	4	50	3,6
	FCM 1 x 6,1mm	CNT 240	5,9 – 6,2	22	23	68	4	50	3,6
	FCM 1 x (...)	Fiber optic	all diameter	22	23	68	4	50	3,6
	FCM 1 x 8 mm	RFF 1/4" -50, SCF 14-50, FSJ1-50A	7 – 8	22	23	68	4	50	3,6
	FCM 1 x 1/4" (9)	LDF 1-50	8 – 9,2	22	23	68	4	50	3,5
	FCM 1 x 1/4" (10)	LCF 14-50, FSJ2-50, RG 8, RG 213, H 1000	9,8 – 10,5	22	23	68	4	50	3,5
	FCM 1 x 1/4" (11)	RF 3/8"-50, LCF38-50, LDF2-50, RG 214	10,5 – 11,5	22	23	68	4	50	3,5
	FCM 1 x 3/8" (14)	RFF 1/2"-50, SCF 12-50, FSJ4-50B	13 - 14	22	28	73	4	50	3,5
	FCM 1 x 1/2" (17)	RF 1/2"-50, LCF 12-50, LDF4-50A	16 - 17	22	28	73	4	50	3,5
	FCM 1 x (...)	Power cable		34	28	73	4	50	3,2
	FCM 1 x 19,5	MCMK 2 x 16 + 16 Feederless DC cable	19,3-19,8	34	44	89	6	50	6,2
	FCM 1 x 7/8" (28)	RF 7/8"-50, LCF78-50A, LDF5-50A	27 – 28	34	44	89	6	50	5,7
	FCM 1 x 1.1/4" (40)	RF1 1/4"-50, LCFS 114-50A, LDF6-50	39 – 40	46	67	117	8	50	9,0
	FCM 1 x 1.5/8" (52)	RF1 5/8"-50,LCF158-50A, LDF7-50A	50 – 52	58	68	120	8	50	11,0
FCM 1 x 2.1/4" (60)	RF 2 1/4"-50, LCF214-50A, LDF12-50	59 - 60	67	80	130	8	25	7,5	
	FCM 2 x 5 mm	CNT 200	4,9 – 5,1	22	43	88	4	50	5
	FCM 2 x 6,1mm	CNT 240	5,9 – 6,2	22	43	88	4	50	5
	FCM 2 x (...)	Fiber optic	all diameter	22	43	88	4	50	5
	FCM 2 x 8 mm	RFF 1/4" -50, SCF 14-50, FSJ1-50A	7 – 8	22	43	88	4	50	5
	FCM 2 x 1/4" (9)	LDF 1-50	8 – 9,2	22	43	88	4	50	5
	FCM 2 x 1/4" (10)	LCF 14-50, FSJ2-50, RG 8, RG 213, H 1000	9,8 – 10,5	22	43	88	4	50	5
	FCM 2 x 1/4" (11)	RF 3/8"-50, LCF38-50, LDF2-50, RG 214	10,5 – 11,5	22	43	88	4	50	5
	FCM 2 x 3/8" (14)	RFF 1/2"-50, SCF 12-50, FSJ4-50B	13 - 14	22	48	93	4	50	4,9
	FCM 2 x 1/2" (17)	RF 1/2"-50, LCF 12-50, LDF4-50A	16 - 17	22	48	93	4	50	4,9
	FCM 2 x (...)	Power cable		34	48	93	4	50	4,7
	FCM 2 x 19,5	MCMK 2 x 16 + 16 Feederless DC cable	19,3-19,8	34	83	128	6	50	9
	FCM 2 x 7/8" (28)	RF 7/8"-50, LCF78-50A, LDF5-50A	27 – 28	34	83	128	6	50	10
	FCM 2 x 1.1/4" (40)	RF1 1/4"-50, LCFS 114-50A, LDF6-50	39 – 40	46	118	168	8	25	7,2
	FCM 2 x 1.5/8" (52)	RF1 5/8"-50,LCF158-50A, LDF7-50A	50 – 52	58	130	180	8	25	9
FCM 2 x 2.1/4" (60)	RF 2 1/4"-50, LCF214-50A, LDF12-50	59 - 60	67	153	203	8	20	9,2	
	FCM 3 x 5 mm	CNT 200	4,9 – 5,1	22	63	108	4	50	6,5
	FCM 3 x 6,1mm	CNT 240	5,9 – 6,2	22	63	108	4	50	6,5
	FCM 3 x (...)	Fiber optic	all diameter	22	63	108	4	50	6,5
	FCM 3 x 8 mm	RFF 1/4" -50, SCF 14-50, FSJ1-50A	7 – 8	22	63	108	4	50	6,5
	FCM 3 x 1/4" (9)	LDF 1-50	8 – 9,2	22	63	108	4	50	6,5
	FCM 3 x 1/4" (10)	LCF 14-50, FSJ2-50, RG 8, RG 213, H 1000	9,8 – 10,5	22	63	108	4	50	6,5
	FCM 3 x 1/4" (11)	RF 3/8"-50, LCF38-50, LDF2-50, RG 214	10,5 – 11,5	22	63	108	4	50	6,5
	FCM 3 x 3/8" (14)	RFF 1/2"-50, SCF 12-50, FSJ4-50B	13 - 14	22	68	113	4	50	6
	FCM 3 x 1/2" (17)	RF 1/2"-50, LCF 12-50, LDF4-50A	16 - 17	22	68	113	4	50	6
	FCM 3 x (...)	Power cable		34	68	113	4	50	6
	FCM 3 x 19,5	MCMK 2 x 16 + 16 Feederless DC cable	19,3-19,8	34	122	167	6	50	13
	FCM 3 x 7/8" (28)	RF 7/8"-50, LCF78-50A, LDF5-50A	27 – 28	34	122	167	6	50	13,3
	FCM 3 x 1.1/4" (40)	RF1 1/4"-50, LCFS 114-50A, LDF6-50	39 – 40	46	168	218	8	25	9,2
	FCM 3 x 1.5/8" (52)	RF1 5/8"-50,LCF158-50A, LDF7-50A	50 – 52	58	193	243	8	25	11,7
FCM 3 x 2.1/4" (60)	RF 2 1/4"-50, LCF214-50A, LDF12-50	59 - 60	67	227	277	8	20	12	
	FCM 4 x 5 mm	CNT 200	4,9 – 5,1	22	82	127	4	50	8
	FCM 4 x 6,1mm	CNT 240	5,9 – 6,2	22	82	127	4	50	8
	FCM 4 x (...)	Fiber optic	all diameter	22	82	127	4	50	8
	FCM 4 x 8 mm	RFF 1/4" -50, SCF 14-50, FSJ1-50A	7 – 8	22	82	127	4	50	7,7
	FCM 4 x 1/4" (9)	LDF 1-50	8 – 9,2	22	82	127	4	50	7,7
	FCM 4 x 1/4" (10)	LCF 14-50, FSJ2-50, RG 8, RG 213, H 1000	9,8 – 10,5	22	82	127	4	50	7,7
	FCM 4 x 1/4" (11)	RF 3/8"-50, LCF38-50, LDF2-50, RG 214	10,5 – 11,5	22	82	127	4	50	7,7
	FCM 4 x 3/8" (14)	RFF 1/2"-50, SCF 12-50, FSJ4-50B	13 - 14	22	88	133	4	50	8
	FCM 4 x 1/2" (17)	RF 1/2"-50, LCF 12-50, LDF4-50A	16 - 17	22	88	133	4	50	8
	FCM 4 x (...)	Power cable		34	88	133	4	50	8
	FCM 4 x 19,5	MCMK 2 x 16 + 16 Feederless DC cable	19,3-19,8	34	161	206	6	50	9,7
	FCM 4 x 7/8" (28)	RF 7/8"-50, LCF78-50A, LDF5-50A	27 – 28	34	161	206	6	50	9,6
	FCM 4 x 1.1/4" (40)	RF1 1/4"-50, LCFS 114-50A, LDF6-50	39 – 40	46	218	268	8	25	11
	FCM 4 x 1.5/8" (52)	RF1 5/8"-50,LCF158-50A, LDF7-50A	50 – 52	58	256	306	8	25	12,5
FCM 4 x 2.1/4" (60)	RF 2 1/4"-50, LCF214-50A, LDF12-50	59 - 60	67	227	350	8	15	8	
	FCM 4 x (...) 2R	Fiber optic	all diameter	34	44	89	4	50	7
	FCM 4 x 1/4" (10) 2R	LCF 14-50, FSJ2-50, RG 8, RG 213, H 1000	9,8 – 10,5	34	44	89	4	50	7
	FCM 4 x 1/4" (11) 2R	RF 3/8"-50, LCF38-50, LDF2-50, RG 214	10,5 – 11,5	34	44	89	4	50	7



FCU

Double universal mount with an anvil

Material: Stainless steel AISI 304
Polyamide with black glass fiber,
resistant to UV radiation

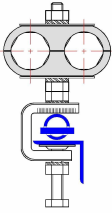
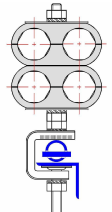
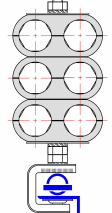
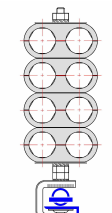

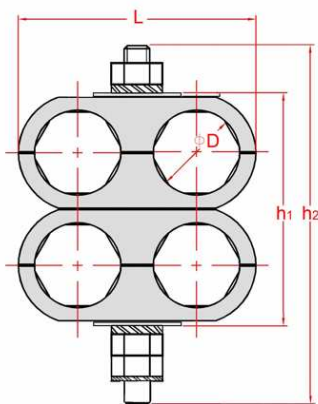
Typ	Kod	Typ kabelu	D	L	H1	h 2	 Nm		 kg
	FCU 2 x (...)	Fiber optic		44	23	63	4	50	11,2
	FCU 2 x 8 mm	RFF 1/4" -50, SCF 14-50, FSJ1-50A	7 - 8	44	23	63	4	50	11,2
	FCU 2 x 1/4" (9)	LDF 1-50	8 - 9,2	44	23	63	4	50	11,2
	FCU 2 x 1/4" (10)	RFF 3/8" -50, SCF38-50, LCF 14-50, FSJ2-50, RG 8, RG 213, H 1000	9,8 - 10,5	44	23	63	4	50	11,5
	FCU 2 x 1/4" (11)	RF 3/8" -50, LCF38-50, LDF2-50, RG 214	10,5 - 11,5	44	23	63	4	50	11,6
	FCU 2 x 3/8" (14)	RFF 1/2" -50, SCF 12-50, FSJ4-50B	13 - 14	59	30	65	4	50	12,5
	FCU 2 x 1/2" (17)	RF 1/2" -50, LCF 12-50, LDF4-50A	16 - 17	59	30	65	4	50	13,2
	FCU 2 x (...)	Power cable		82	42	82	6	50	15,0
	FCU 2 x 19,5		19,3-19,8	82	42	82	6	50	15,0
	FCU 2 x 7/8" (28)	RF 7/8" -50, LCF78-50A, LDF5-50A	27 - 28	82	42	82	6	50	15,0
	FCU 2 x 1.1/4" (40)	RF1 1/4" -50, LCFS 114-50A, LDF6-50	39 - 40	112	56	93	8	25	9,4
	FCU 2 x 1.5/8" (52)	RF1 5/8" -50, LCF158-50A, LDF7-50A	50 - 52	136	68	102	8	25	10,0
	FCU 4 x (...)	Fiber optic		44	46	86	4	50	12,7
	FCU 4 x 8 mm	RFF 1/4" -50, SCF 14-50, FSJ1-50A	7 - 8	44	46	86	4	50	12,7
	FCU 4 x 1/4" (9)	LDF 1-50	8 - 9,2	44	46	86	4	50	12,7
	FCU 4 x 1/4" (10)	RFF 3/8" -50, SCF38-50, LCF 14-50, FSJ2-50, RG 8, RG 213, H 1000	9,8 - 10,5	44	46	86	4	50	13,0
	FCU 4 x 1/4" (11)	RF 3/8" -50, LCF38-50, LDF2-50, RG 214	10,5 - 11,5	44	46	86	4	50	13,0
	FCU 4 x 3/8" (14)	RFF 1/2" -50, SCF 12-50, FSJ4-50B	13 - 14	59	60	95	4	50	15,6
	FCU 4 x 1/2" (17)	RF 1/2" -50, LCF 12-50, LDF4-50A	16 - 17	59	60	95	4	50	16,2
	FCU 4 x (...)	Power cable		59	84	124	6	25	9,3
	FCU 4 x 19,5		19,3 - 19,8	82	84	124	6	25	9,3
	FCU 4 x 7/8" (28)	RF 7/8" -50, LCF78-50A, LDF5-50A	27 - 28	82	84	124	6	25	9,3
	FCU 4 x 1.1/4" (40)	RF1 1/4" -50, LCFS 114-50A, LDF6-50	39 - 40	112	112	149	8	25	12,3
	FCU 4 x 1.5/8" (52)	RF1 5/8" -50, LCF158-50A, LDF7-50A	50 - 52	136	136	170	8	20	10,6
	FCU 6 x (...)	Fiber optic		44	69	109	4	50	14,0
	FCU 6 x 8 mm	RFF 1/4" -50, SCF 14-50, FSJ1-50A	7 - 8	44	69	109	4	50	14,0
	FCU 6 x 1/4" (9)	LDF 1-50	8 - 9,2	44	69	109	4	50	14,0
	FCU 6 x 1/4" (10)	RFF 3/8" -50, SCF38-50, LCF 14-50, FSJ2-50, RG 8, RG 213, H 1000	9,8 - 10,5	44	69	109	4	50	14,3
	FCU 6 x 1/4" (11)	RF 3/8" -50, LCF38-50, LDF2-50, RG 214	10,5 - 11,5	44	69	109	4	50	14,6
	FCU 6 x 3/8" (14)	RFF 1/2" -50, SCF 12-50, FSJ4-50B	13 - 14	59	90	125	4	50	18,4
	FCU 6 x 1/2" (17)	RF 1/2" -50, LCF 12-50, LDF4-50A	16 - 17	59	90	125	4	50	19,0
	FCU 6 x (...)	Power cable		82	126	166	6	25	11,3
	FCU 6 x 19,5		19,3 - 19,8	82	126	166	6	25	11,3
	FCU 6 x 7/8" (28)	RF 7/8" -50, LCF78-50A, LDF5-50A	27 - 28	82	126	166	6	25	11,3
	FCU 6 x 1.1/4" (40)	RF1 1/4" -50, LCFS 114-50A, LDF6-50	39 - 40	112	168	205	8	20	12,2
	FCU 6 x 1.5/8" (52)	RF1 5/8" -50, LCF158-50A, LDF7-50A	50 - 52	136	204	238	8	20	13,2
	FCU 8 x (...)	Fiber optic		44	92	132	4	50	15,5
	FCU 8 x 8 mm	RFF 1/4" -50, SCF 14-50, FSJ1-50A	7 - 8	44	92	132	4	50	15,5
	FCU 8 x 1/4" (9)	LDF 1-50	8 - 9,2	44	92	132	4	50	15,5
	FCU 8 x 1/4" (10)	RFF 3/8" -50, SCF38-50, LCF 14-50, FSJ2-50, RG 8, RG 213, H 1000	9,8 - 10,5	44	92	132	4	50	15,5
	FCU 8 x 1/4" (11)	RF 3/8" -50, LCF38-50, LDF2-50, RG 214	10,5 - 11,5	44	92	132	4	50	15,5
	FCU 8 x 3/8" (14)	RFF 1/2" -50, SCF 12-50, FSJ4-50B	13 - 14	59	120	155	4	50	16,5
	FCU 8 x 1/2" (17)	RF 1/2" -50, LCF 12-50, LDF4-50A	16 - 17	59	120	155	4	50	16,5
	FCU 8 x (...)	Power cable		82	168	208	6	25	12,5
	FCU 8 x 19,5		19,3 - 19,8	82	168	208	6	25	12,5
	FCU 8 x 7/8" (28)	RF 7/8" -50, LCF78-50A, LDF5-50A	27 - 28	82	168	208	6	25	12,5
	FCU 8 x 1.1/4" (40)	RF1 1/4" -50, LCFS 114-50A, LDF6-50	39 - 40	112	224	261	8	20	14,5
	FCU 8 x 1.5/8" (52)	RF1 5/8" -50, LCF158-50A, LDF7-50A	50 - 52	136	272	306	8	15	12,5



CU

Double universal mount

Material: Stainless steel AISI 304
Polyamide with black glass fiber,
resistant to UV radiation

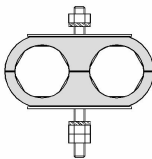
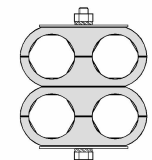
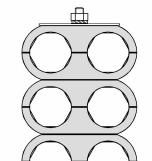
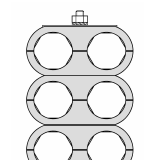

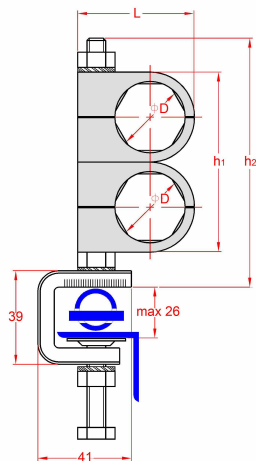
Typ	Kod	Typ kabelu	D	L	H1	h2	 Nm		
	CU 2 x (...)	Fiber optic		44	23	63	4	50	11,2
	CU 2 x 8 mm	RFF 1/4"-50, SCF 14-50, FSJ1-50A	7 - 8	44	23	63	4	50	11,2
	CU 2 x 1/4" (9)	LDF 1-50	8 - 9,2	44	23	63	4	50	11,2
	CU 2 x 1/4" (10)	RFF 3/8"-50, SCF38-50, LCF 14-50, FSJ2-50, RG 8, RG 213, H 1000	9,8 - 10,5	44	23	63	4	50	11,5
	CU 2 x 1/4" (11)	RF 3/8"-50, LCF38-50, LDF2-50, RG 214	10,5 - 11,5	44	23	63	4	50	11,6
	CU 2 x 3/8" (14)	RFF 1/2"-50, SCF 12-50, FSJ4-50B	13 - 14	59	29	69	4	50	12,5
	CU 2 x 1/2" (17)	RF 1/2"-50, LCF 12-50, LDF4-50A	16 - 17	59	29	69	4	50	13,2
	CU 2 x (...)	Power cable		82	42	82	6	50	15,0
	CU 2 x 19,5		19,3 - 19,8	82	42	82	6	50	15,0
	CU 2 x 7/8" (28)	RF 7/8"-50, LCF78-50A, LDF5-50A	27 - 28	82	42	82	6	50	15,0
	CU 2 x 1.1/4" (40)	RF1 1/4"-50, LCFS 114-50A, LDF6-50	39 - 40	112	56	96	8	25	9,4
CU 2 x 1.5/8" (52)	RF1 5/8"-50,LCF158-50A, LDF7-50A	50 - 52	136	69	109	8	25	10,0	
	CU 4 x (...)	Fiber optic		44	43	83	4	50	12,7
	CU 4 x 8 mm	RFF 1/4"-50, SCF 14-50, FSJ1-50A	7 - 8	44	43	83	4	50	12,7
	CU 4 x 1/4" (9)	LDF 1-50	8 - 9,2	44	43	83	4	50	12,7
	CU 4 x 1/4" (10)	RFF 3/8"-50, SCF38-50, LCF 14-50, FSJ2-50, RG 8, RG 213, H 1000	9,8 - 10,5	44	43	83	4	50	13,0
	CU 4 x 1/4" (11)	RF 3/8"-50, LCF38-50, LDF2-50, RG 214	10,5 - 11,5	44	43	83	4	50	13,0
	CU 4 x 3/8" (14)	RFF 1/2"-50, SCF 12-50, FSJ4-50B	13 - 14	59	56	96	4	50	15,6
	CU 4 x 1/2" (17)	RF 1/2"-50, LCF 12-50, LDF4-50A	16 - 17	59	56	96	4	50	16,2
	CU 4 x (...)	Power cable		82	80	120	6	25	9,3
	CU 4 x 19,5		19,3 - 19,8	82	80	120	6	25	9,3
	CU 4 x 7/8" (28)	RF 7/8"-50, LCF78-50A, LDF5-50A	27 - 28	82	80	120	6	25	9,3
	CU 4 x 1.1/4" (40)	RF1 1/4"-50, LCFS 114-50A, LDF6-50	39 - 40	112	109	149	8	25	12,3
CU 4 x 1.5/8" (52)	RF1 5/8"-50,LCF158-50A, LDF7-50A	50 - 52	136	133	173	8	20	10,6	
	CU 6 x (...)	Fiber optic		44	64	14	4	50	14,0
	CU 6 x 8 mm	RFF 1/4"-50, SCF 14-50, FSJ1-50A	7 - 8	44	64	104	4	50	14,0
	CU 6 x 1/4" (9)	LDF 1-50	8 - 9,2	44	64	104	4	50	14,0
	CU 6 x 1/4" (10)	RFF 3/8"-50, SCF38-50, LCF 14-50, FSJ2-50, RG 8, RG 213, H 1000	9,8 - 10,5	44	64	104	4	50	14,3
	CU 6 x 1/4" (11)	RF 3/8"-50, LCF38-50, LDF2-50, RG 214	10,5 - 11,5	44	64	104	4	50	14,6
	CU 6 x 3/8" (14)	RFF 1/2"-50, SCF 12-50, FSJ4-50B	13 - 14	59	82	122	4	50	18,4
	CU 6 x 1/2" (17)	RF 1/2"-50, LCF 12-50, LDF4-50A	16 - 17	59	82	122	4	50	19,0
	CU 6 x (...)	Power cable		82	120	160	6	25	11,3
	CU 6 x 19,5		19,3 - 19,8	82	120	160	6	25	11,3
	CU 6 x 7/8" (28)	RF 7/8"-50, LCF78-50A, LDF5-50A	27 - 28	82	120	160	6	25	11,3
	CU 6 x 1.1/4" (40)	RF1 1/4"-50, LCFS 114-50A, LDF6-50	39 - 40	112	163	203	8	20	12,2
CU 6 x 1.5/8" (52)	RF1 5/8"-50,LCF158-50A, LDF7-50A	50 - 52	136	198	238	8	20	13,2	
	CU 8 x (...)	Fiber optic		44	85	125	4	50	15,5
	CU 8 x 8 mm	RFF 1/4"-50, SCF 14-50, FSJ1-50A	7 - 8	44	85	125	4	50	15,5
	CU 8 x 1/4" (9)	LDF 1-50	8 - 9,2	44	85	125	4	50	15,5
	CU 8 x 1/4" (10)	RFF 3/8"-50, SCF38-50, LCF 14-50, FSJ2-50, RG 8, RG 213, H 1000	9,8 - 10,5	44	85	125	4	50	15,5
	CU 8 x 1/4" (11)	RF 3/8"-50, LCF38-50, LDF2-50, RG 214	10,5 - 11,5	44	85	125	4	50	15,5
	CU 8 x 3/8" (14)	RFF 1/2"-50, SCF 12-50, FSJ4-50B	13 - 14	59	109	149	4	50	15,5
	CU 8 x 1/2" (17)	RF 1/2"-50, LCF 12-50, LDF4-50A	16 - 17	59	109	149	4	50	15,5
	CU 8 x (...)	Power cable		82	160	200	6	25	13,5
	CU 8 x 19,5		19,3 - 19,8	82	160	200	6	25	13,5
	CU 8 x 7/8" (28)	RF 7/8"-50, LCF78-50A, LDF5-50A	27 - 28	82	160	200	6	25	13,5
	CU 8 x 1.1/4" (40)	RF1 1/4"-50, LCFS 114-50A, LDF6-50	39 - 40	112	217	257	8	20	14,6
CU 8 x 1.5/8" (52)	RF1 5/8"-50,LCF158-50A, LDF7-50A	50 - 52	136	263	303	8	20	16,0	



FU

Universal mount with an anvil

Material: Stainless steel AISI 304
Polyamide with black glass fiber,
resistant to UV radiation

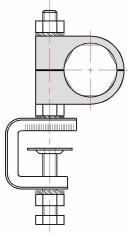
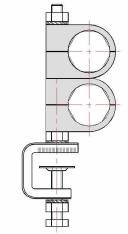
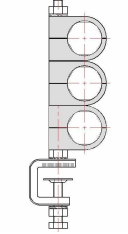
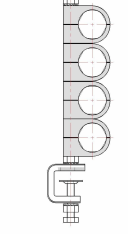
Typ	Kod	Typ kabelu	D	L	h1	h2			
							Nm		kg
	FU 1 x 5 mm	CNT 200	4,9 – 5,1	41	24	60	4	50	10,3
	FU 1 x 6,1mm	CNT 240	5,9 – 6,2	41	24	60	4	50	10,3
	FU 1 x (...)	Fiber optic		41	24	60	4	50	10,3
	FU 1 x 8 mm	RFF 1/4" -50, SCF 14-50, FSJ1-50A	7 – 8	41	24	60	4	50	10,3
	FU 1 x 1/4" (9)	LDF 1-50	8 – 9,2	41	24	60	4	50	10,3
	FU 1 x 1/4" (10)	RFF 3/8"-50, SCF38-50, LCF 14-50, FSJ2-50, RG 8, RG 213, H 1000	9,8 – 10,5	41	24	60	4	50	10,3
	FU 1 x 1/4" (11)	RF 3/8"-50, LCF38-50, LDF2-50, RG 214	10,5 – 11,5	41	24	60	4	50	10,3
	FU 1 x 3/8" (14)	RFF 1/2"-50, SCF 12-50, FSJ4-50B	13 - 14	41	24	60	4	50	10,3
	FU 1 x 1/2" (17)	RF 1/2"-50, LCF 12-50, LDF4-50A	16 - 17	41	24	60	4	50	10,3
	FU 1 x (...)	Power cable		53	38	75	6	50	11,3
	FU 1 x 19,5		19,3 – 19,8	53	38	75	6	50	11,3
	FU 1 x 7/8" (28)	RF 7/8"-50, LCF78-50A, LDF5-50A	27 – 28	53	38	75	6	50	11,3
		FU 2 x 5 mm	CNT 200	4,9 – 5,1	41	48	85	4	50
FU 2 x 6,1mm		CNT 240	5,9 – 6,2	41	48	85	4	50	12,4
FU 2 x (...)		Fiber optic		41	48	85	4	50	12,4
FU 2 x 8 mm		RFF 1/4" -50, SCF 14-50, FSJ1-50A	7 – 8	41	48	85	4	50	12,4
FU 2 x 1/4" (9)		LDF 1-50	8 – 9,2	41	48	85	4	50	12,4
FU 2 x 1/4" (10)		RFF 3/8"-50, SCF38-50, LCF 14-50, FSJ2-50, RG 8, RG 213, H 1000	9,8 – 10,5	41	48	85	4	50	12,4
FU 2 x 1/4" (11)		RF 3/8"-50, LCF38-50, LDF2-50, RG 214	10,5 – 11,5	41	48	85	4	50	12,4
FU 2 x 3/8" (14)		RFF 1/2"-50, SCF 12-50, FSJ4-50B	13 - 14	41	48	85	4	50	12,4
FU 2 x 1/2" (17)		RF 1/2"-50, LCF 12-50, LDF4-50A	16 - 17	41	48	85	4	50	11,8
FU 2 x (...)		Power cable		53	76	113	6	50	14,0
FU 2 x 19,5			19,3 – 19,8	53	76	113	6	50	14,0
FU 2 x 7/8" (28)		RF 7/8"-50, LCF78-50A, LDF5-50A	27 – 28	53	76	113	6	50	14,0
FU 2 x 1.1/4" (40)		RF1 1/4"-50, LCFS 114-50A, LDF6-50	39 – 40	64,5	108	144	8	25	8,3
FU 2 x 1.5/8" (52)	RF1 5/8"-50,LCF158-50A, LDF7-50A	50 – 52	74,5	130	165	8	25	9,0	
	FU 3 x 5 mm	CNT 200	4,9 – 5,1	41	72	109	4	50	14,3
	FU 3 x 6,1mm	CNT 240	5,9 – 6,2	41	72	109	4	50	14,3
	FU 3 x (...)	Fiber optic		41	72	109	4	50	14,3
	FU 3 x 8 mm	RFF 1/4" -50, SCF 14-50, FSJ1-50A	7 – 8	41	72	109	4	50	14,3
	FU 3 x 1/4" (9)	LDF 1-50	8 – 9,2	41	72	109	4	50	14,3
	FU 3 x 1/4" (10)	RFF 3/8"-50, SCF38-50, LCF 14-50, FSJ2-50, RG 8, RG 213, H 1000	9,8 – 10,5	41	72	109	4	50	14,3
	FU 3 x 1/4" (11)	RF 3/8"-50, LCF38-50, LDF2-50, RG 214	10,5 – 11,5	41	72	109	4	50	14,3
	FU 3 x 3/8" (14)	RFF 1/2"-50, SCF 12-50, FSJ4-50B	13 - 14	41	72	109	4	50	14,3
	FU 3 x 1/2" (17)	RF 1/2"-50, LCF 12-50, LDF4-50A	16 - 17	41	72	109	4	50	13,7
	FU 3 x (...)	Power cable		53	114	151	6	50	16,3
	FU 3 x 19,5		19,3 - 19,8	53	114	151	6	50	16,3
	FU 3 x 7/8" (28)	RF 7/8"-50, LCF78-50A, LDF5-50A	27 – 28	53	114	151	6	50	16,3
	FU 3 x 1.1/4" (40)	RF1 1/4"-50, LCFS 114-50A, LDF6-50	39 – 40	64,5	162	198	8	25	10,0
FU 3 x 1.5/8" (52)	RF1 5/8"-50,LCF158-50A, LDF7-50A	50 – 52	74,5	195	230	8	25	11,0	
	FU 4 x 5 mm	CNT 200	4,9 – 5,1	41	96	133	4	50	16,3
	FU 4 x 6,1mm	CNT 240	5,9 – 6,2	41	96	133	4	50	16,3
	FU 4 x (...)	Fiber optic		41	96	133	4	50	16,3
	FU 4 x 8 mm	RFF 1/4" -50, SCF 14-50, FSJ1-50A	7 – 8	41	96	133	4	50	16,3
	FU 4 x 1/4" (9)	LDF 1-50	8 – 9,2	41	96	133	4	50	16,3
	FU 4 x 1/4" (10)	RFF 3/8"-50, SCF38-50, LCF 14-50, FSJ2-50, RG 8, RG 213, H 1000	9,8 – 10,5	41	96	133	4	50	16,3
	FU 4 x 1/4" (11)	RF 3/8"-50, LCF38-50, LDF2-50, RG 214	10,5 – 11,5	41	96	133	4	50	16,3
	FU 4 x 3/8" (14)	RFF 1/2"-50, SCF 12-50, FSJ4-50B	13 - 14	41	96	133	4	50	16,3
	FU 4 x 1/2" (17)	RF 1/2"-50, LCF 12-50, LDF4-50A	16 - 17	41	96	133	4	50	15,4
	FU 4 x (...)	Power cable		53	152	189	6	25	10,0
	FU 4 x 19,5		19,3 - 19,8	53	152	189	6	25	10,0
	FU 4 x 7/8" (28)	RF 7/8"-50, LCF78-50A, LDF5-50A	27 – 28	53	152	189	6	25	10,0
	FU 4 x 1.1/4" (40)	RF1 1/4"-50, LCFS 114-50A, LDF6-50	39 – 40	64,5	216	252	8	20	9,3
FU 4 x 1.5/8" (52)	RF1 5/8"-50,LCF158-50A, LDF7-50A	50 – 52	74,5	260	295	8	15	8,0	

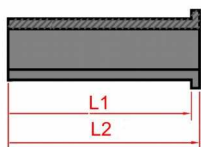
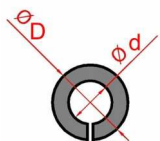

Clamps with rubber

Material: Stainless steel AISI 304
Polyamide with black glass fiber,
resistant to UV radiation
Rubber - EPDM

Kod	ØD	Ød	L1	L2		
RC 1/4" (...)	10,0	7,2	47,0	49	100	0,25
RC 7/8" (10,5)	27,0	15,0	41,0	44	100	2,4
RC 7/8" (15,5)	27,0	10,5	41	44	100	2,1